

Саперный

ТИ1-1

ТР5-2

ТР5-1

ШЛИССЕЛЬБУРГСКОЕ ШОССЕ

Т1Ж2-2

ДОРОЖНАЯ УЛИЦА

ТР3-1

ТИ4_2

ТР5-1

НЕВСКАЯ УЛИЦА

ТД1-2_2

ТД2_2

ТР5-2

ЦЕНТРАЛЬНАЯ УЛИЦА

ТПД1_2

ТК3

ТПД2_2

Т1Ж2-2

СТАНЦИОННАЯ УЛИЦА

САПЕРНЫЙ ПЕР.

МИНСКАЯ УЛИЦА

ВОСТОЧНАЯ УЛИЦА

ДОРОЖНАЯ УЛИЦА

ПЕТРОЗАВОДСКОЕ ШОССЕ

ТП4

ТПД2_2

ТР5-2

ТР5-2

ТР5-2

ТР1

ТЗЖ2/ТР1

ТПД2_2

ТП4

ТЗЖ2/ТР1

ТПД1_2/ТР1

ТИ1-1

Т1Ж2-2/ТР1

ТИ1-2

ТПД1_2/ТР1

ТР1

Т1Ж2-2/ТР1

ТПД1_2/ТР1

ТР1

ТИ1-2

ТР1

180

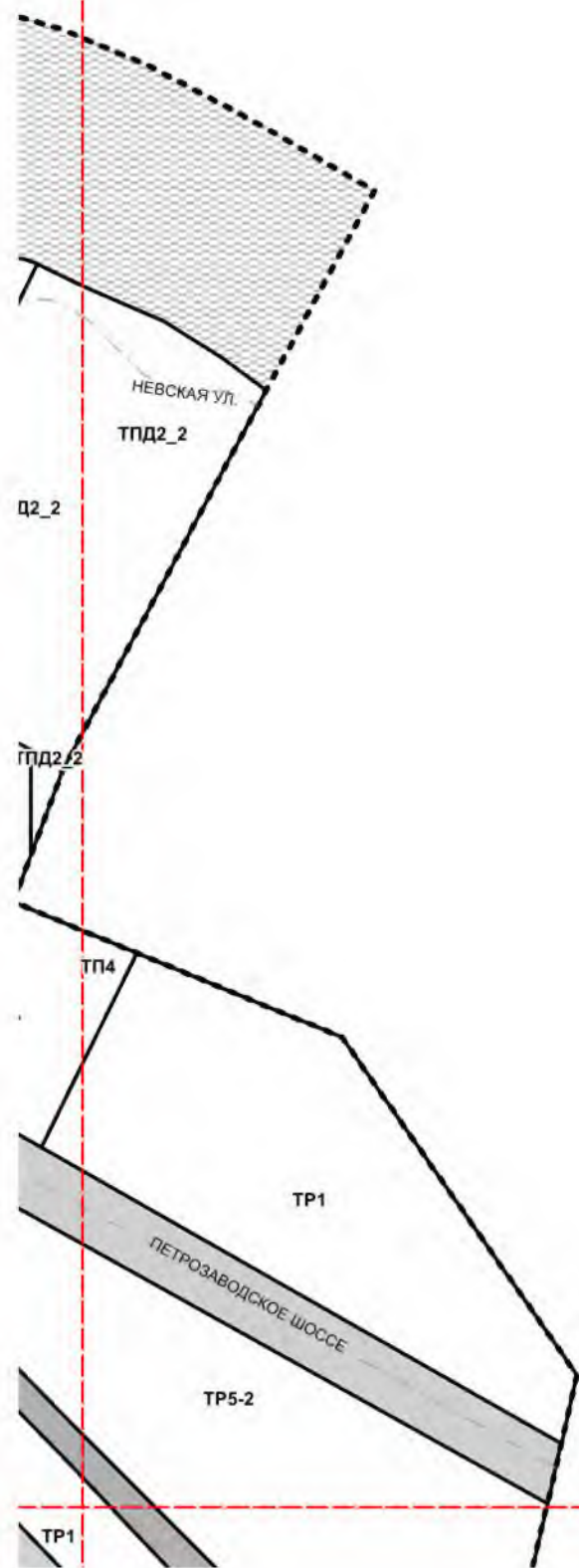

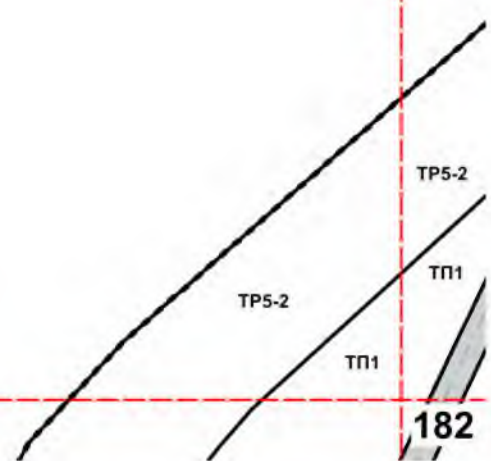
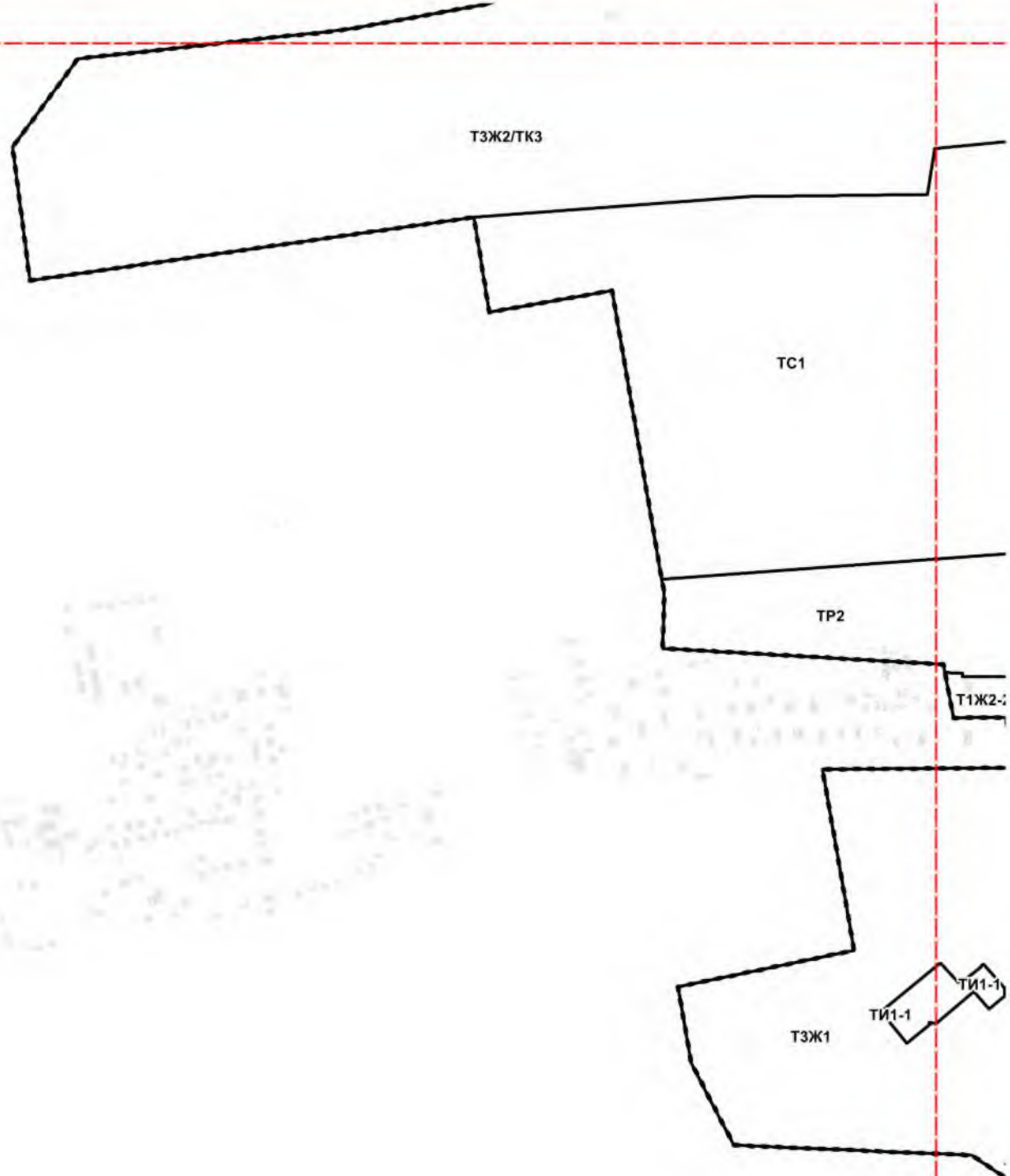



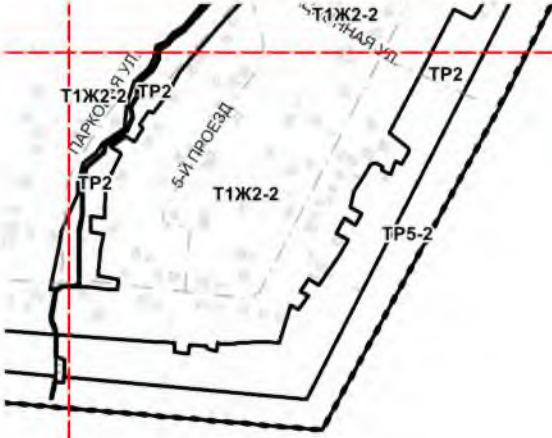



TK1



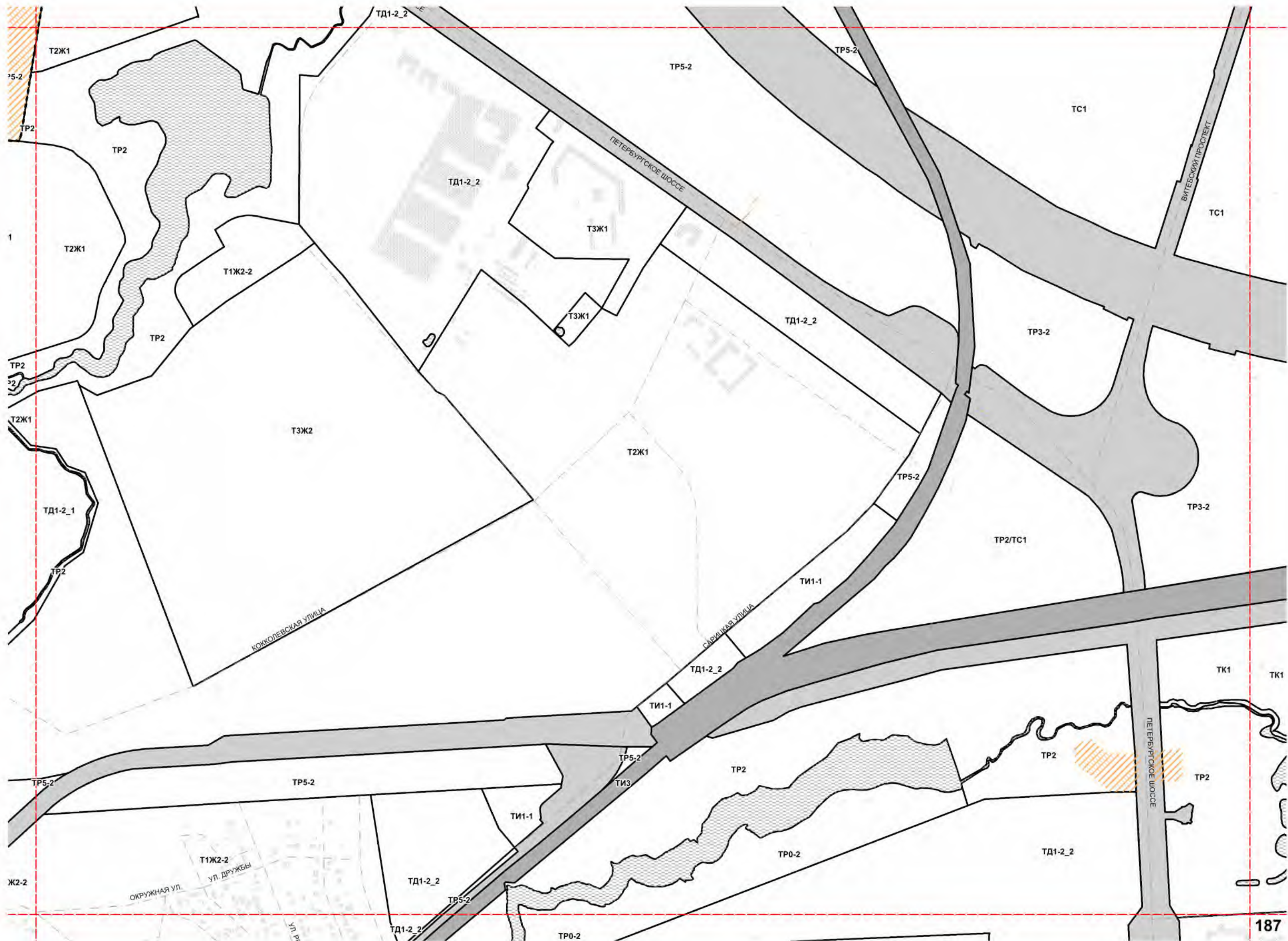

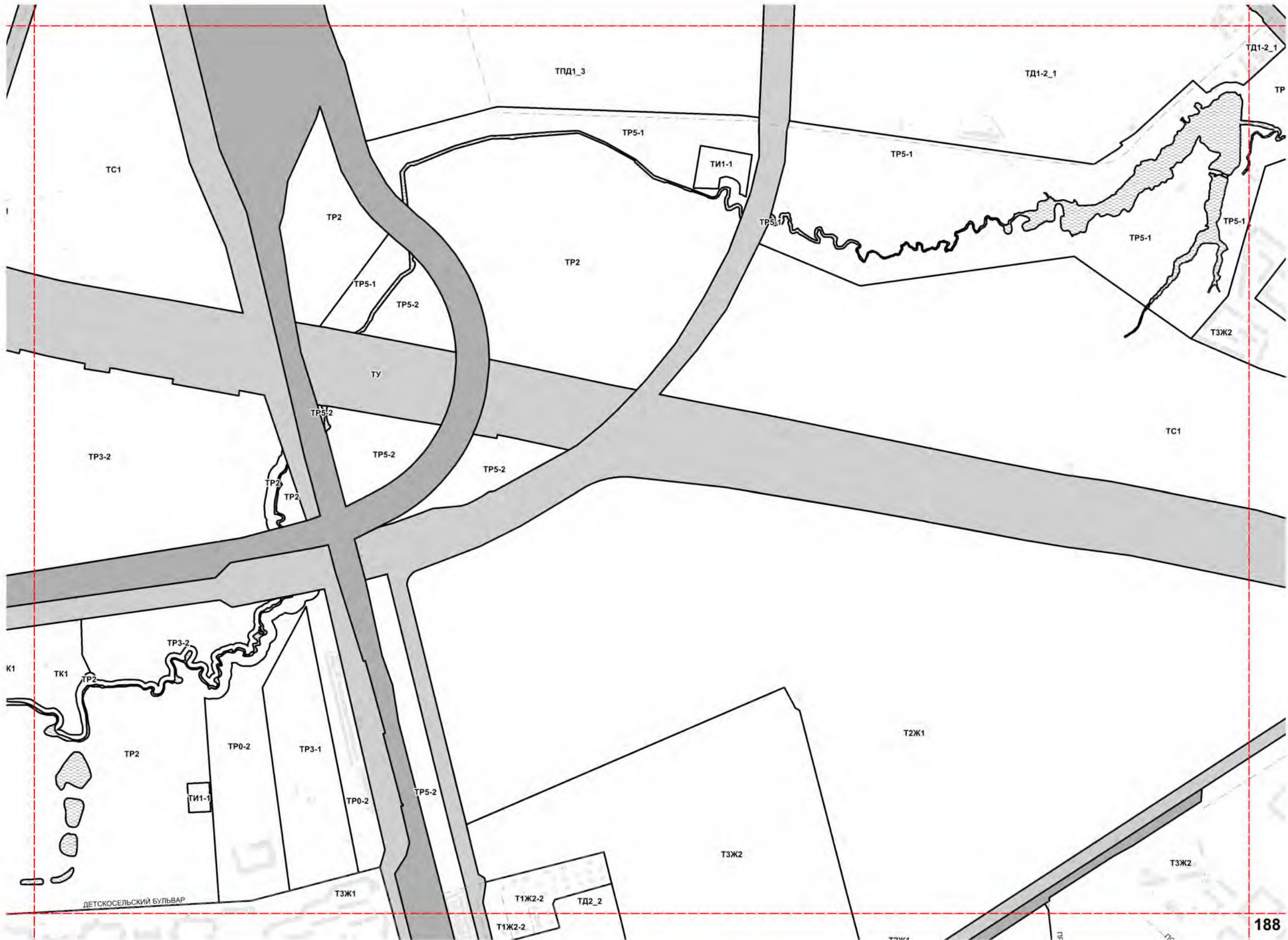





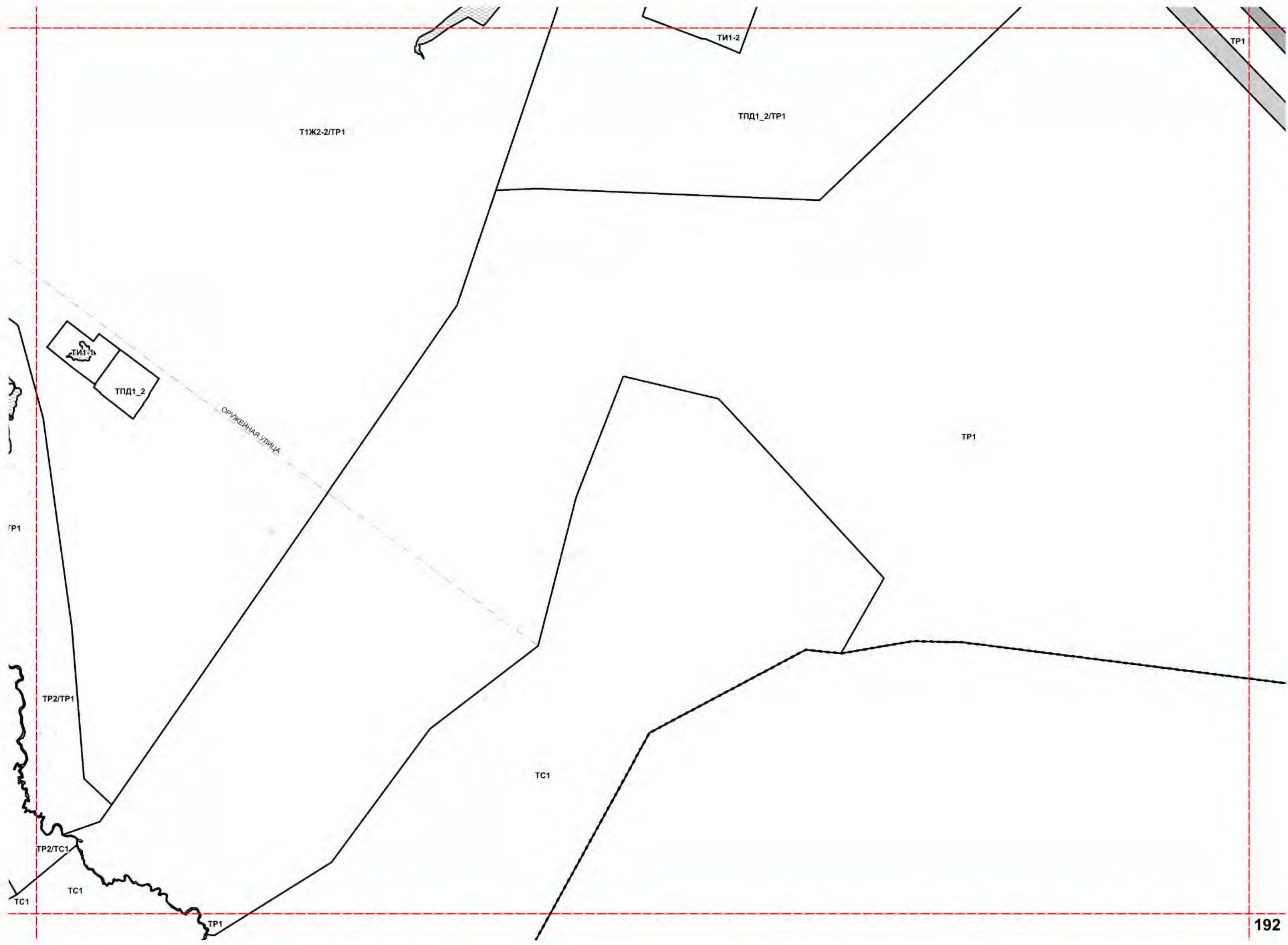

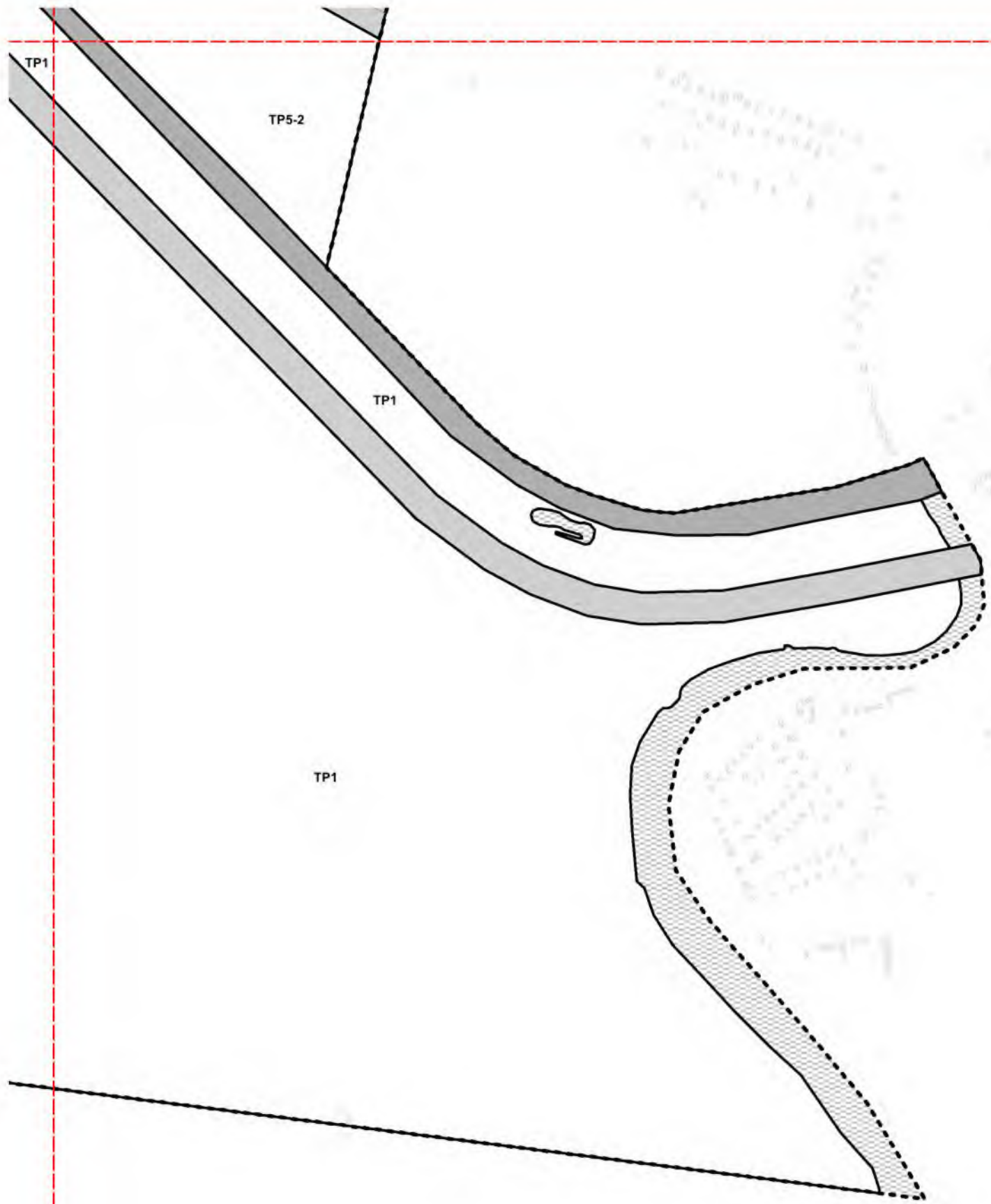

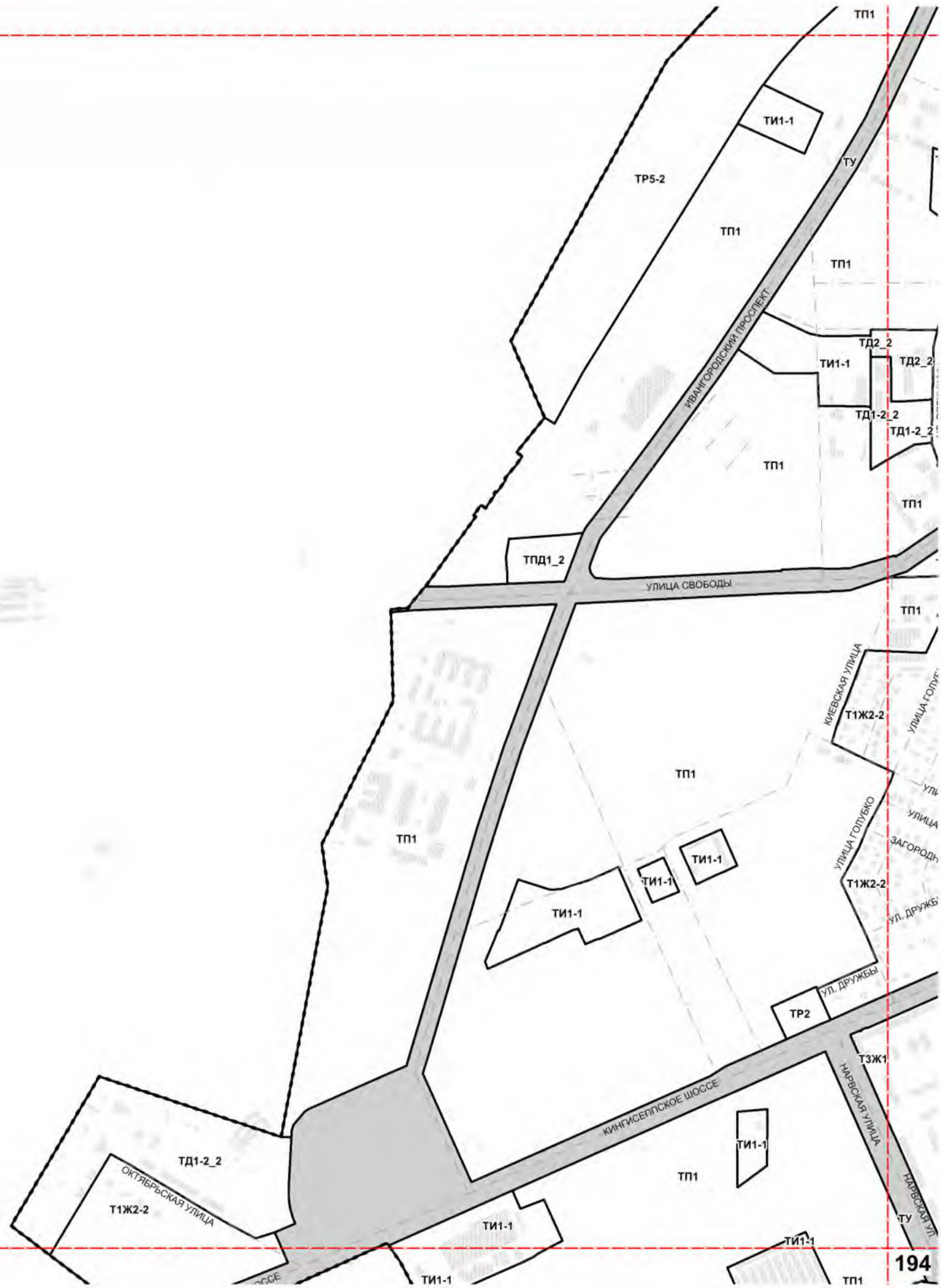





ТД1-2_1

ТД1-2_1/ТС1

ТПД1_3

Александровская

ТС1

Т2Ж1

Т1Ж2-2

ТД1-2_2

ТД1-2_2

Т1Ж2-2

Т1Ж2-2

ТР2/ТС

ТР2/ТС1

ТР2/ТС1

ТС1







TC1

TP1

TC1

TC1

TK1

ПОПРАВКА

TC1





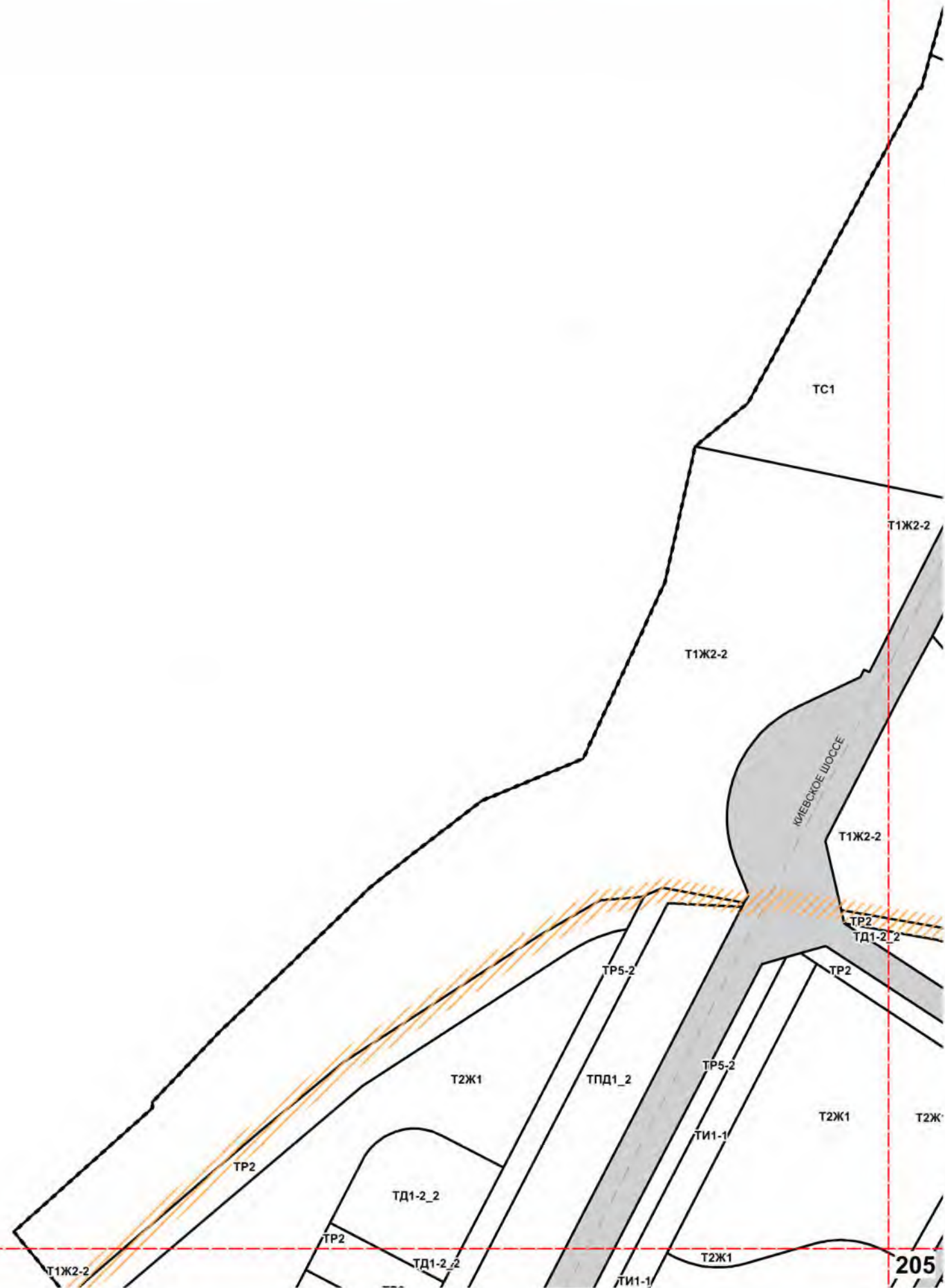



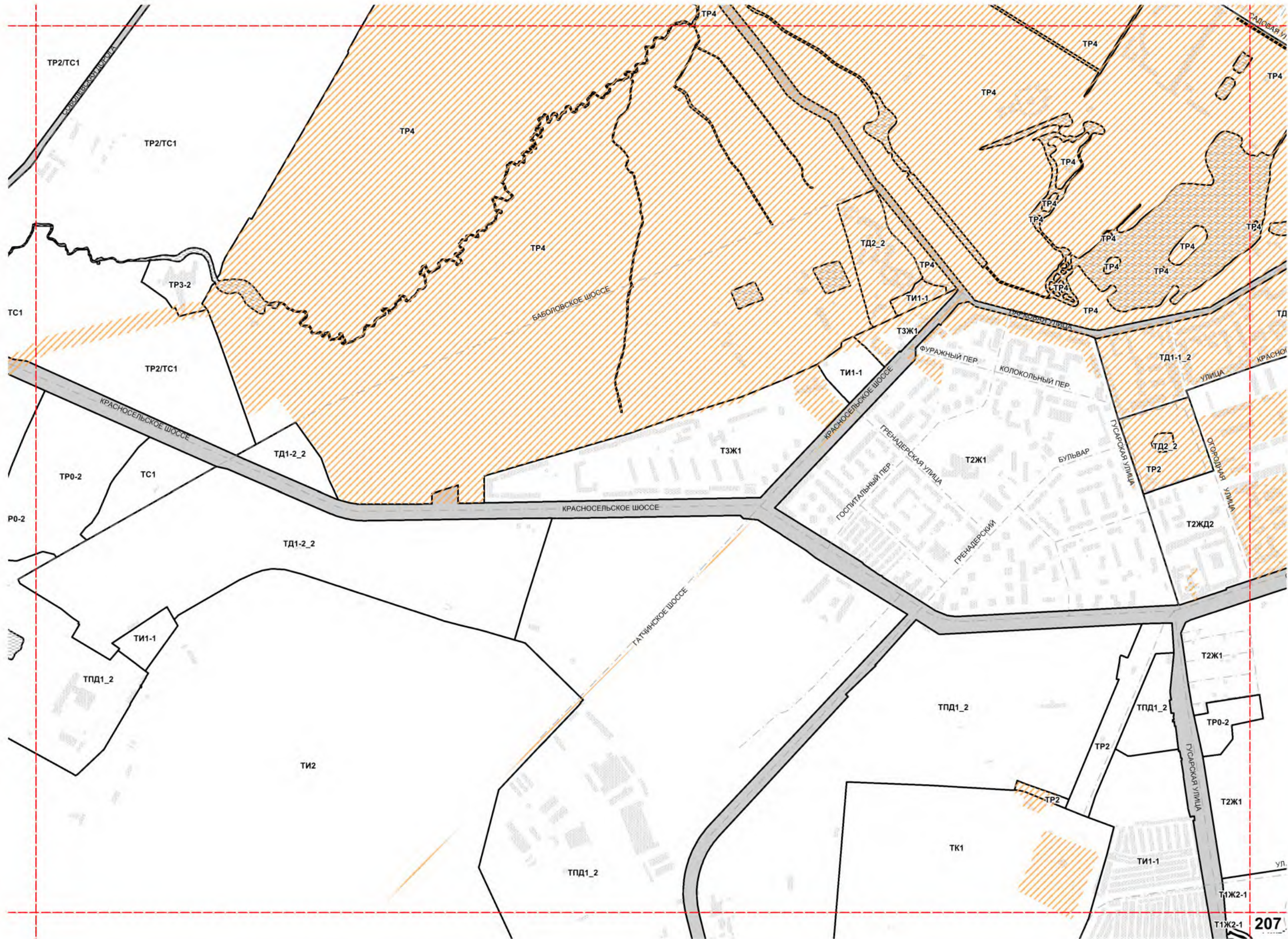



Гярлево

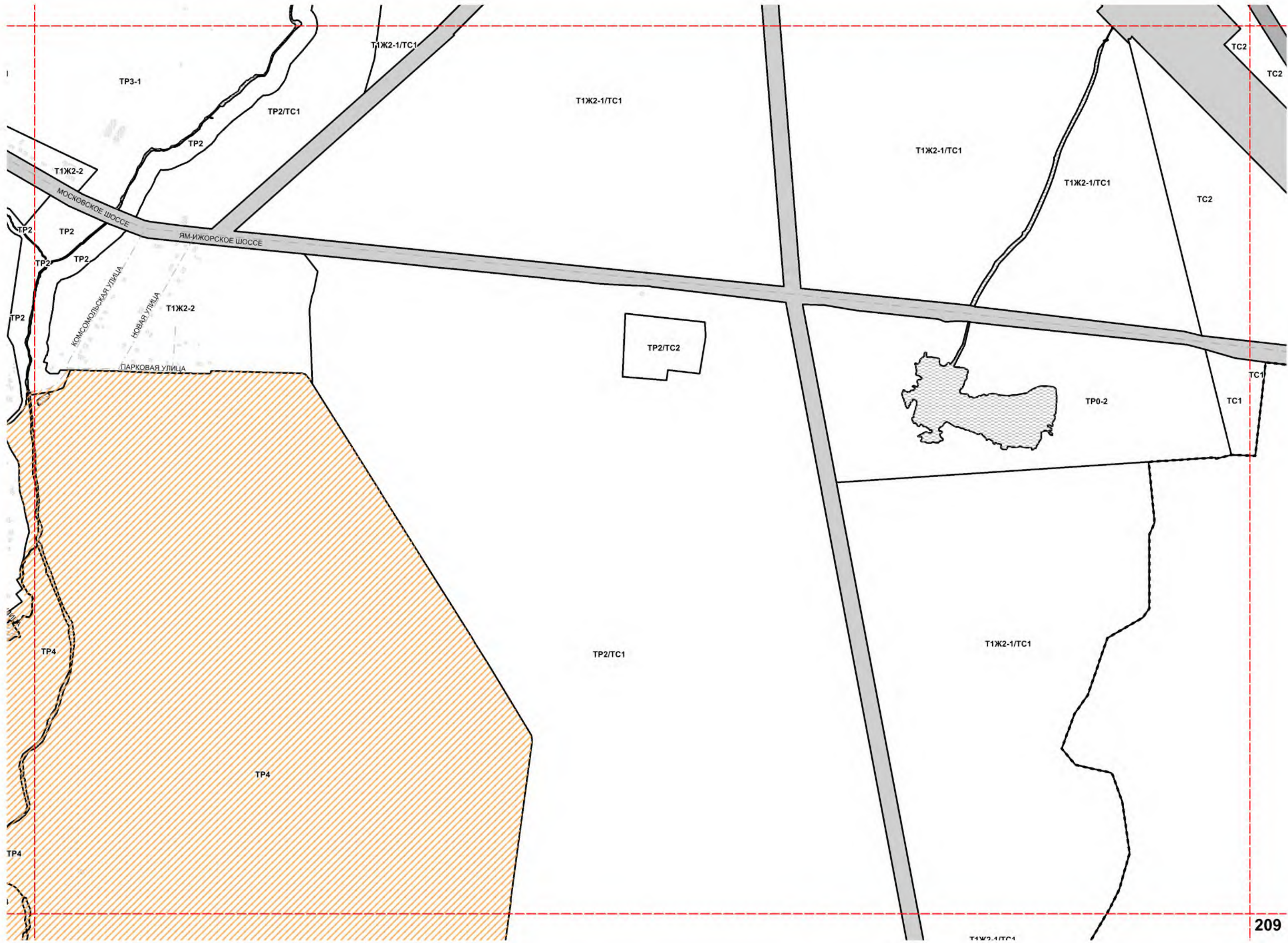

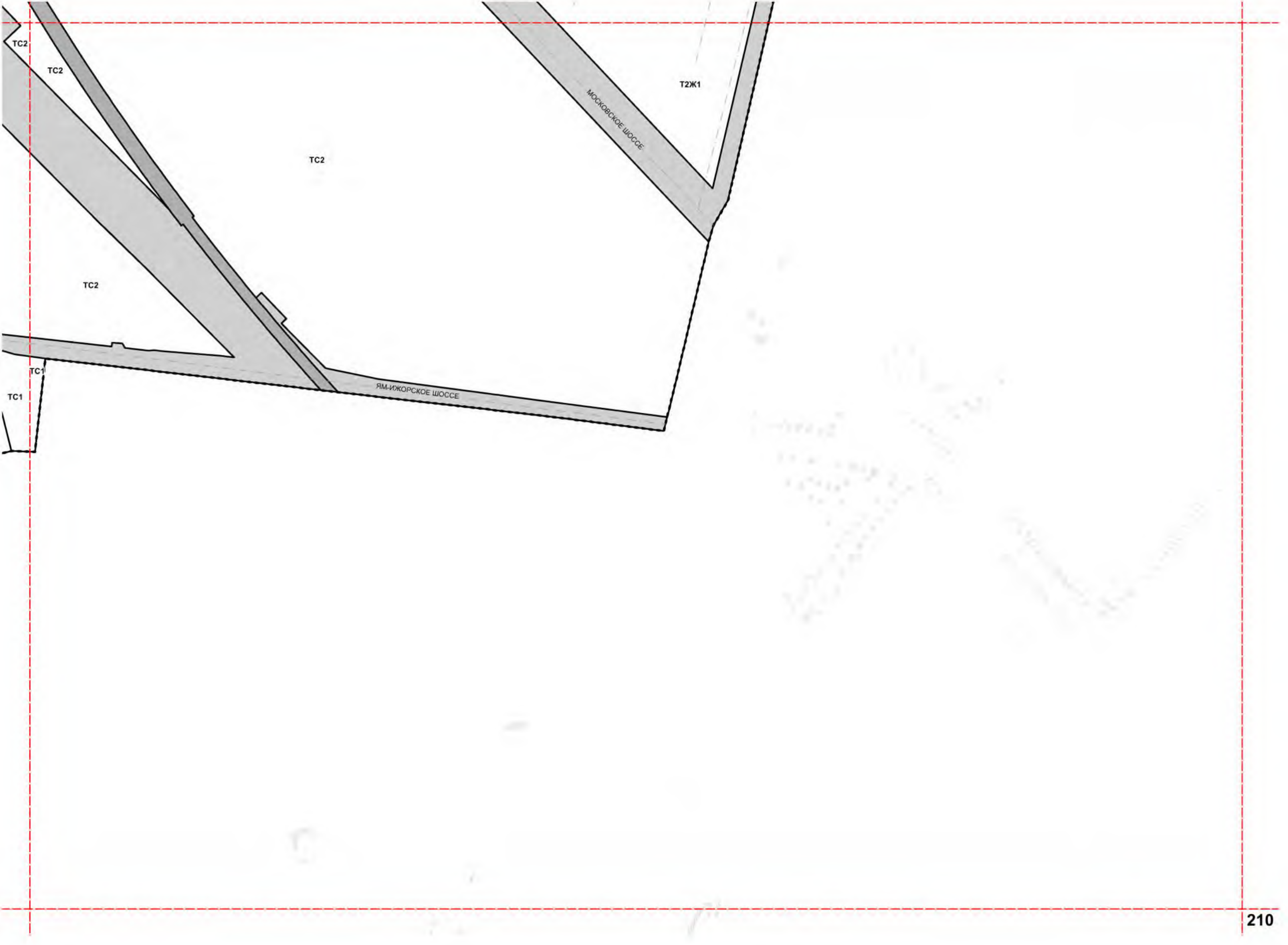

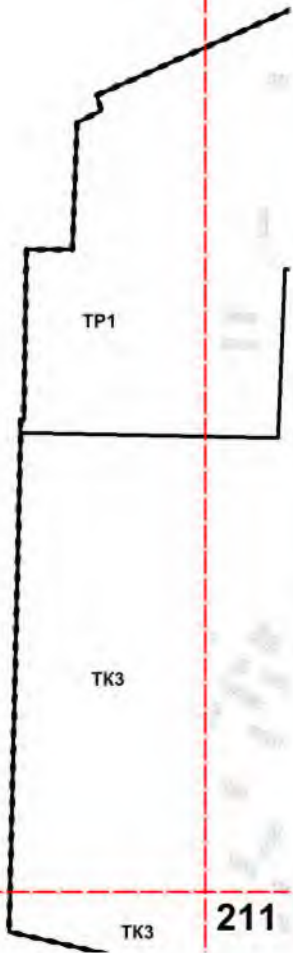



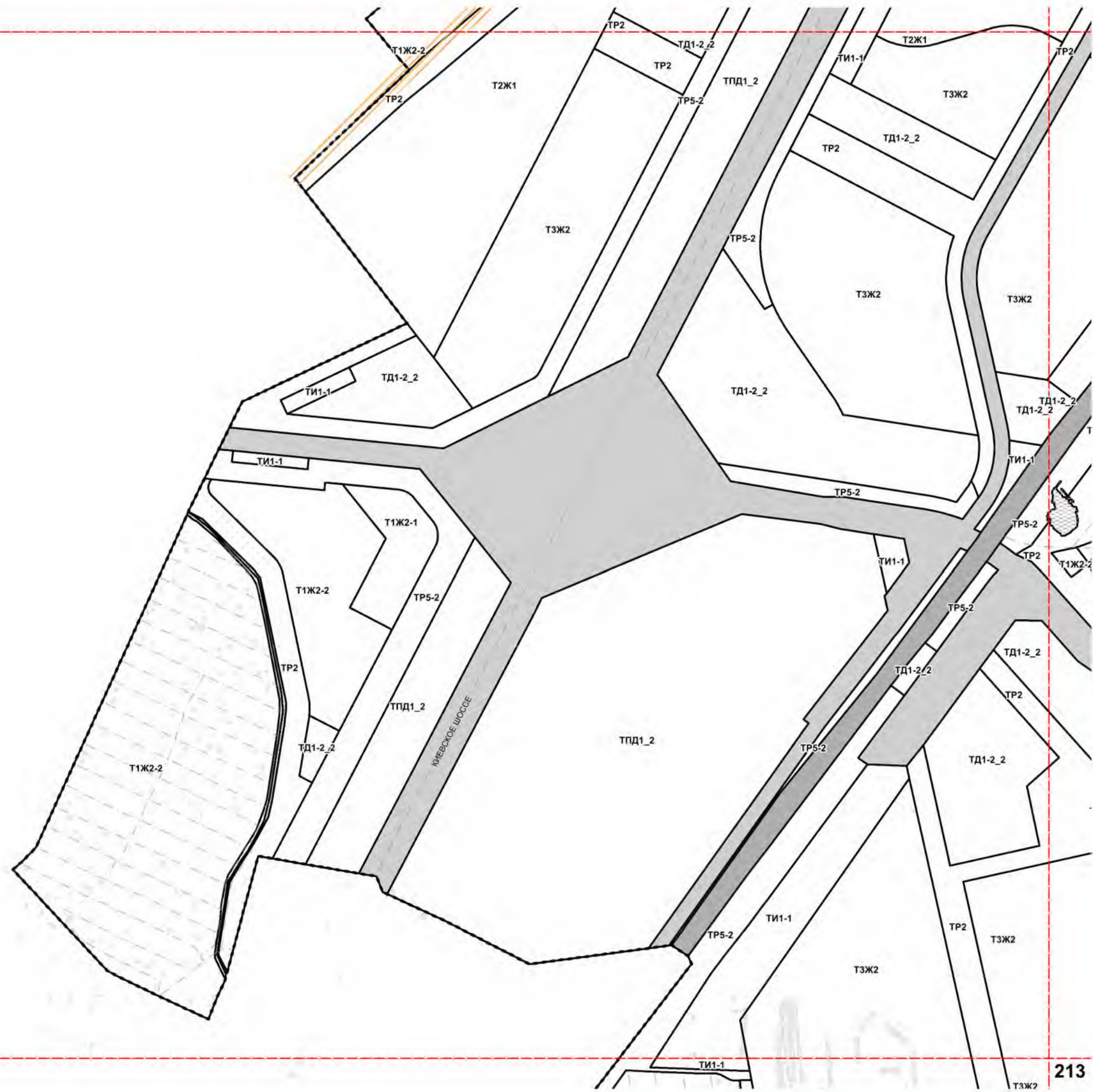



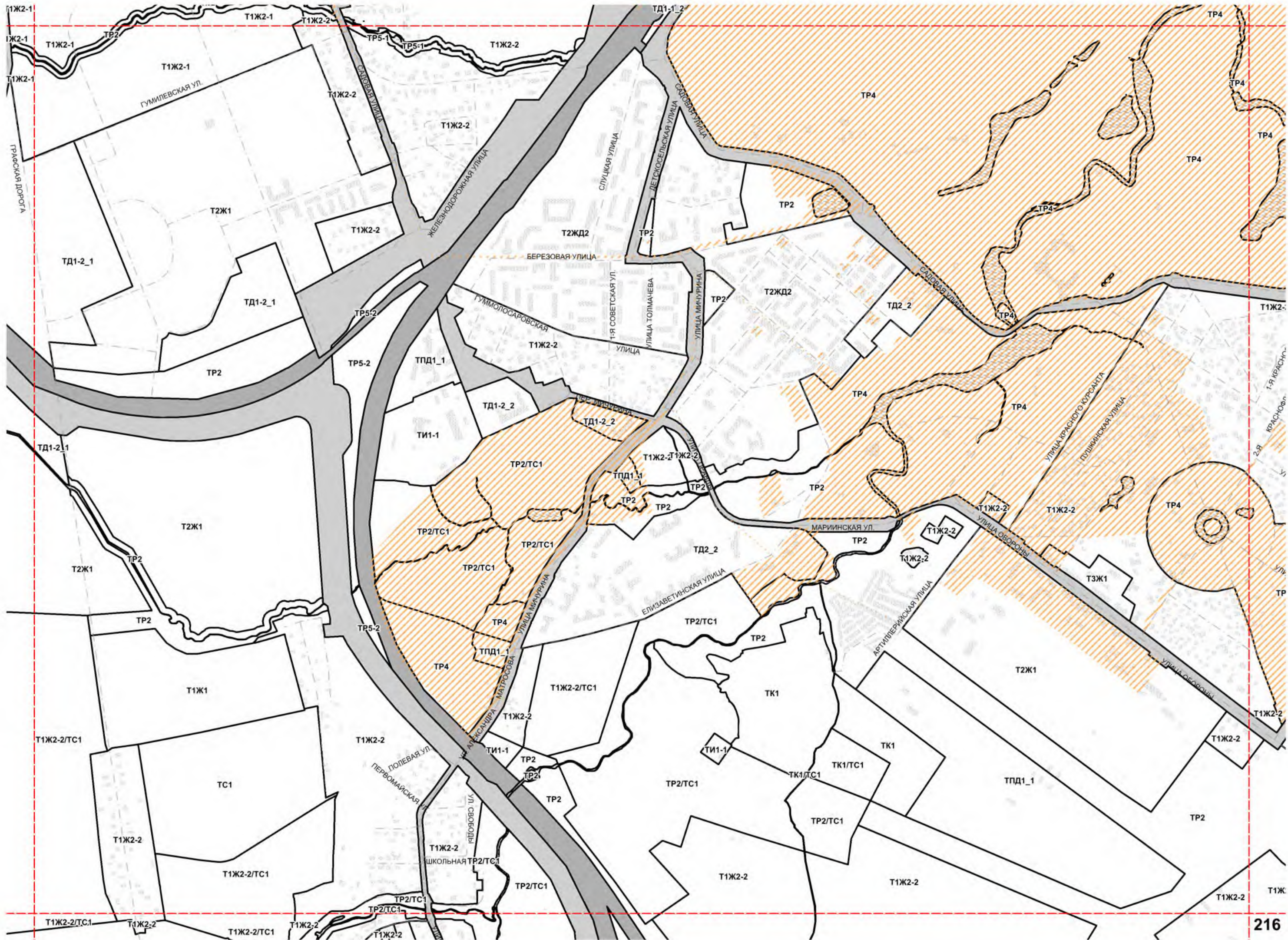



TK3

3

TK3



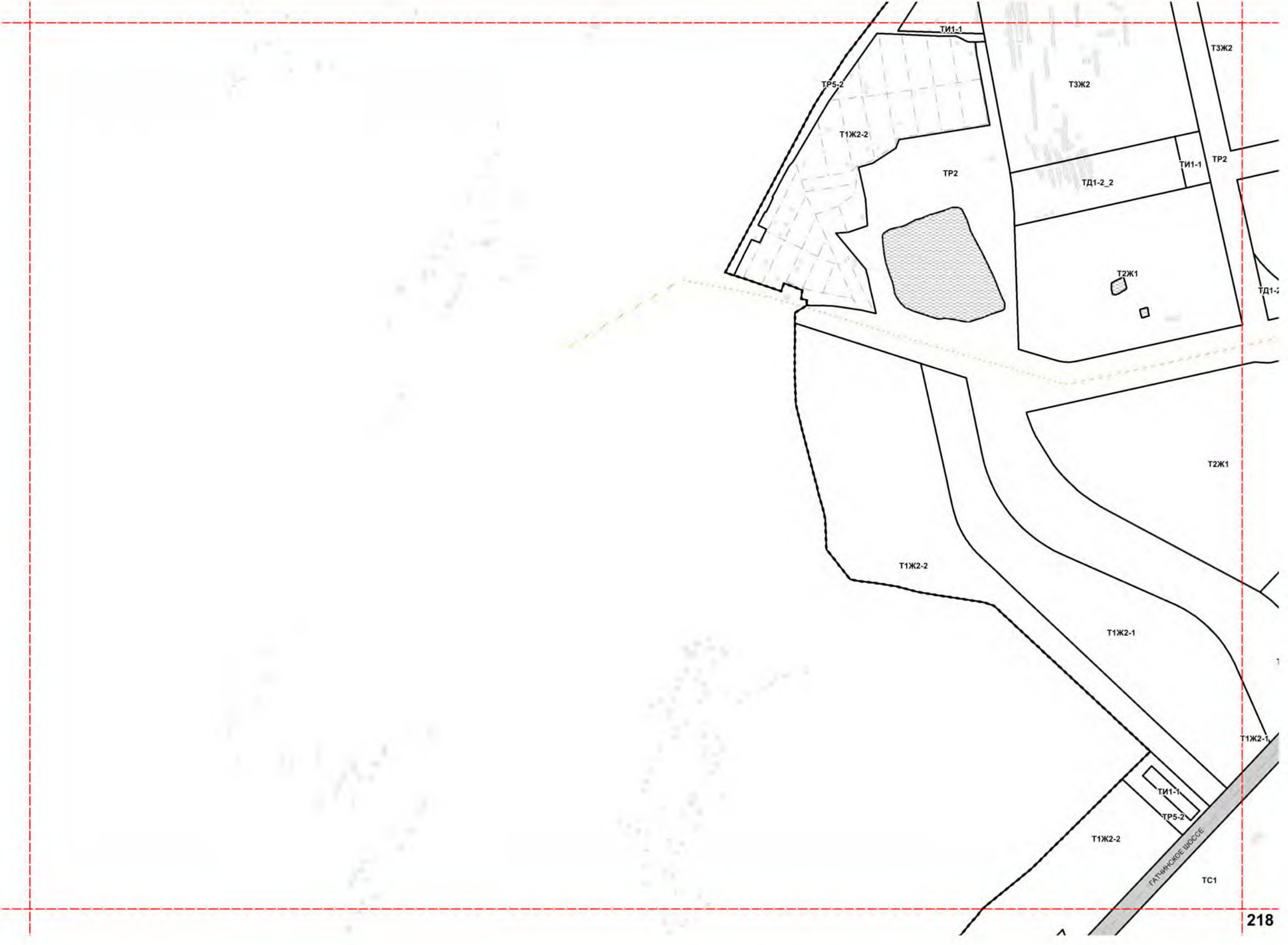



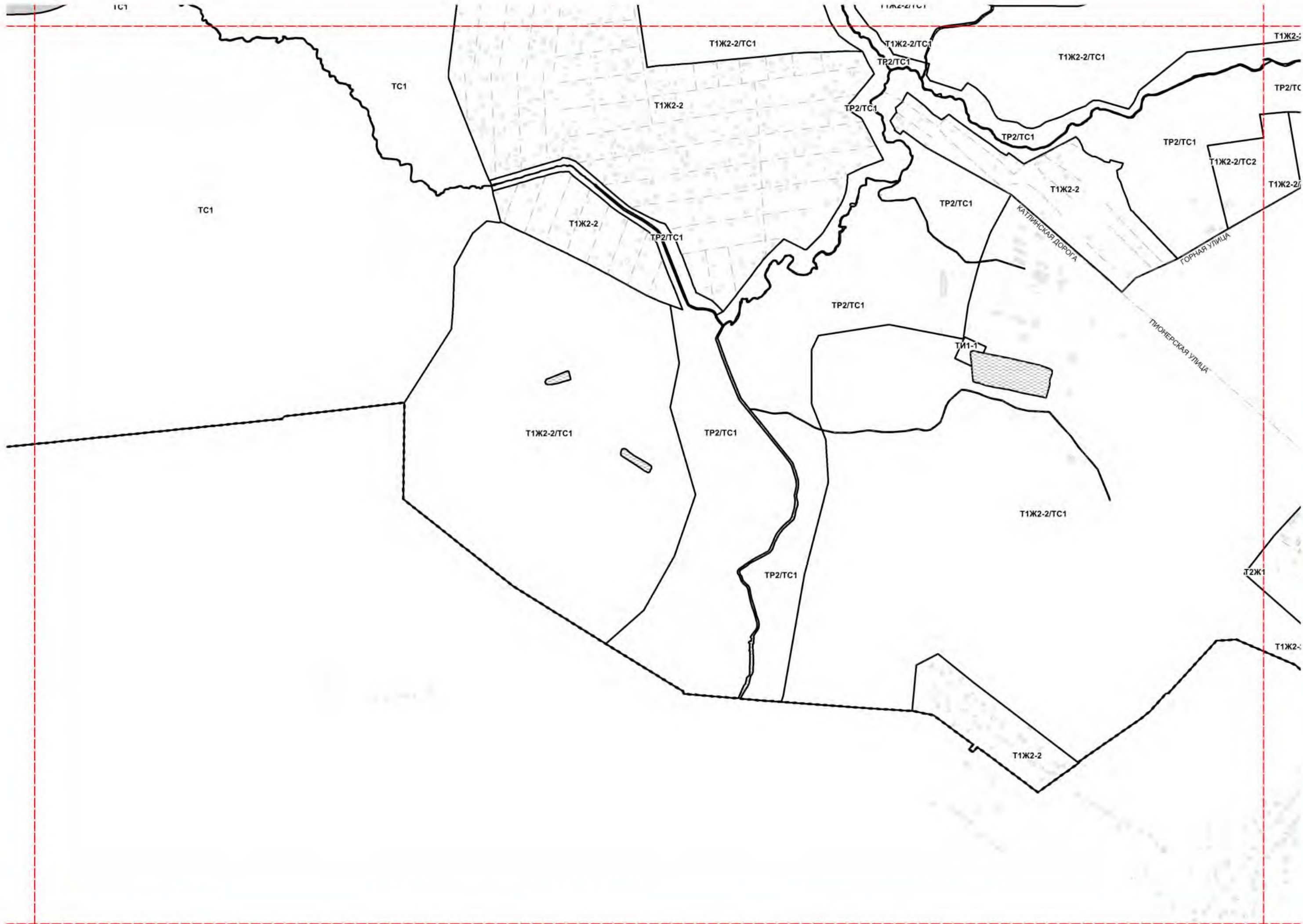

1Ж2-2

1 ЖИЗНЬ

TC1

T1Ж2-2

TP2

T1Ж2-2

TC1

T1Ж2-2

